

Speed, Accuracy and Precision – All in One Package

The MultiStar family of products features Field Analyzers, a Multi-Tone Radiated Immunity Test System and a Precision DSP EMI Receiver that all utilize groundbreaking technology to perform multiple tasks simultaneously. These products dramatically reduce test time, provide more information and assure the highest degree of accuracy.

The MultiStar Field Analyzers measure modulated electric fields and CW fields with a sampling rate of 1.5 million times per second. The MultiStar Multi-Tone Radiated Immunity Test System tests multiple frequencies concurrently, taking just minutes to perform tests that used to require hours. The MultiStar Precision DSP Receiver can measure a signal using 4 CISPR detectors simultaneously, reducing test times from days to hours.

Carl Mueller Demonstrates AR's Multi-Tone Test Solution



Visit www.arworld.us/MultiToneVid to view a demo on our Multi-Tone Tester or scan this page with the Layar app to watch on your mobile device.

multi
family of products



MultiStar Field Analyzer



MultiStar Precision DSP Receiver

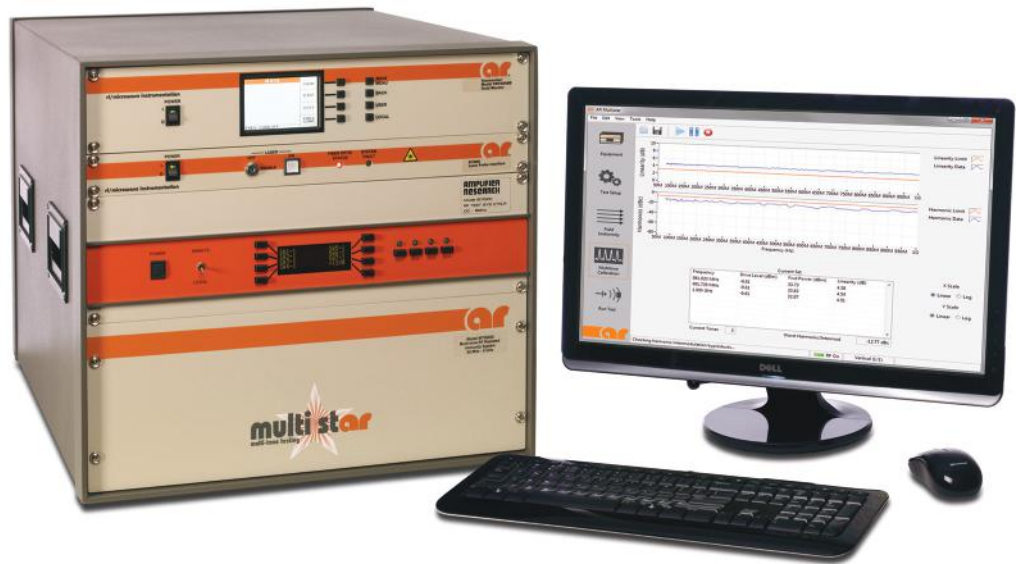

MultiStar Multi-Tone Tester



For a capsule summary of the Multitone system, watch this 60 second video by AR Sales Manager, Chuck Britten: www.arworld.us/tour

RF Immunity Testing Faster And More Versatile Than Ever!



Wider Bandwidth Now Available!

The MultiStar Multi-Tone Tester Offers a Complete Testing Solutions to the Following Standards:

MT06000A

Radiated Immunity

- EN/IEC 61000-4-3
- EN/IEC 60601-1, -2
- EN 50130-4
- EN 61000-6-1/2
- EN 55024

New! MT06002

Radiated Immunity

- EN/IEC 61000-4-3
- ISO11452-2 Auto (ALSE)
- ISO11452-3 Auto (TEM cells)
- ISO11451-5 Auto (Strip Line)
- ISO11451-2 Full Vehicle
- DO-160 Section 20.5 (Substitution Method)
- EN/IEC 60601-1, -2
- EN 50130-4
- EN 61000-6-1/2
- EN 55024

Conducted Immunity

- EN/IEC 61000-4-6
- ISO11452-4 Auto (BCI Method)
- DO-160 Section 20.4 (Substitution Method)
- MIL STD 461 CS114
- EN/IEC 60601-1, -2

NEW FEATURES
Additional Automotive Test Profiles
Ability to Operate Up to 4 Field Probes Simultaneously
Testing Now From 30 Hz to 6 GHz

Maximize Your RF Immunity Testing and Minimize Costs

Models MT06000A and MT06002

The MT06000A and MT06002 models (MultiStar Multi-Tone Tester) are state-of-the-art systems that are designed to test RF Radiated and Conducted Immunity faster than ever before. With the enhanced AR MultiStar Multi-Tone Tester commercial, aviation, and automotive industries, will perform RF radiated and conducted immunity testing faster, more accurately, more efficiently, and more closely to a real-world environment.

The number of tones is only limited by the signal generator bandwidth (up to 1 GHz) and the size of the amplifier.

The **MT06000A** contains all the features needed to perform IEC 61000-4-3 RF radiated immunity testing, required by many European test standard standards.

The **new enhanced MT06002** offers testing from 10 kHz to 6 GHz, greatly expanding testing capabilities to include both RF radiated and conducted immunity standards. And, with a 1GHz instantaneous bandwidth the number of tones has increased exponentially, vastly increasing the speed of testing.

Amplifiers, antennas and directional couplers can be sized and selected based on your required field levels and testing needs.

Up to 4 RF amplifiers, antennas and directional couplers can be controlled by the MultiStar Multi-Tone Tester. In addition, up to 4 field probes can be monitored with the M1 option.

These systems contain a vector signal transceiver, RF pre-amplifier, RF field probe(s), RF switch matrix, and automated immunity test software. These system components are contained in a single housing, which eliminates setup issues.

The MultiStar software includes automated routines to calibrate the field and maximize the speed of the test, by generating the most tones possible, while still meeting the Linearity and Harmonics requirements.

In the event of an EUT failure, margin investigation (thresholding) and traditional single tone testing can be performed to window the test only in the areas of concern.

New! Try Our Interactive MultiStar ROI Calculator

Enter your actual data to discover labor hours savings, ROI and more. Visit arworld.us/MTCalc

This file can be accessed by one user at a time. If you have an immediate need for the file, please email your contact information with 'ROI Calculator' in the subject line to info@arworld.us. You will receive the file within one or two business days.

Single Tone Test Time (Hrs.)
Based on your inputs



Multi-Tone Test Time (Hrs.)
Based on your inputs

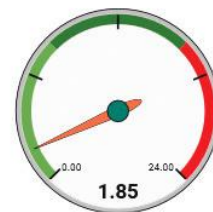

RF Immunity Test Time (Cycle)

(test cycle: 2 Antenna polarities, 1-sec dwell, 4sides of EUT & 8160 frequency step size)

Improvements in Testing

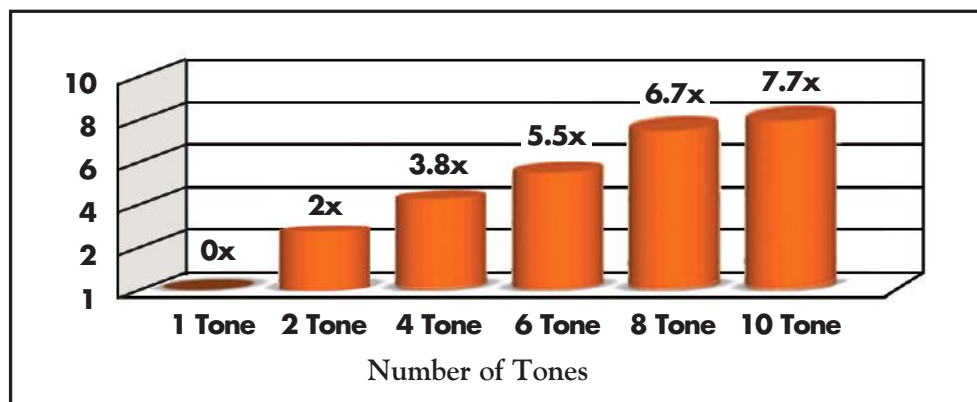

IEC 61000-4-3 1% step sizes, taking into account dwell time

* For More Information See Application Note #71 at www.arworld.us/pdfs/appNotes/AppNote71.pdf

Precision DSP Receiver: Amazing Speed, Incredible Accuracy.



The DER2018 is a state-of-the-art DSP-based emissions receiver with an integrated computer capable of reducing your valuable test time from days to minutes. It is extremely easy to operate with all functions menu driven and displayed on a supplied 23" widescreen monitor.

This digital receiver offers continuous coverage from 20 Hz to 18 GHz with an instantaneous bandwidth of 140 MHz, and with the optional down converter, coverage is up to 40 GHz.

Peak, Quasi-Peak, Average, and RMS-average detections are processed simultaneously at up to 8,192 frequency points and interpolated using a proprietary algorithm to allow scans in seconds, catch short duration transient disturbances, and identify emissions using a fast time-base 3D display.

And if this wasn't enough, it complies with CISPR-16-1-1.



DER2018

20 Hz-18 GHz, expandable to 40 GHz

The DER2018 Digital Emissions Receiver offers continuous coverage from 20 Hz to 18 GHz with 140 MHz instantaneous bandwidth. This receiver combines state-of-the-art sensitivity, dynamic range, accuracy and convenience of operation. It complies with CISPR-16-1-1.

The MultiStar Precision DSP Receiver system includes a built-in computer and interfaces with standard data storage, high resolution video devices and features a removable hard drive. A 23" widescreen monitor, keyboard and mouse are included.

Emission Testing Solutions to the following standards:

- MIL-STD-461
- DO160
- CISPR 11/EN 55011
- CISPR 22/EN55022
- CISPR 14/EN55014
- FCC Part 15

140 MHz wide, pre-selected, instantaneous bandwidth*

- Easy to use – all functions are easily accessible through a graphical user interface.
- PEAK, QUASI-PEAK, AVERAGE, and RMSAVERAGE detections are processed simultaneously at up to 8,192 frequency points and interpolated using a proprietary algorithm. These features enable the user to:
 - Display and record detector results as continuous spectra with 1 Hz resolution
 - Sweep 9 kHz - 30 MHz (CISPR bands A & B) in 2 seconds with all CISPR detectors
 - Process 30 - 1000 MHz (CISPR bands C & D) in 7 seconds with all CISPR detectors
 - Reduce multi-day tasks to minutes
 - Catch short-duration transient disturbances
 - Identify emissions using fast time-base 3D display

- Capability for user to set up, and save for future use, all of the needed test parameters including limit lines, start/stop frequencies, applied correction factors, dwell time at each frequency, transducer correction table, input attenuation, units to be used for the displayed level, and more..

*140 MHz instantaneous bandwidth is available in CISPR bands C, D and E with -6dB resolution bandwidth ≥ 50 kHz. The entire CISPR bands A and B are covered instantaneously with -6dB bandwidths at least 100 Hz and 9 kHz respectively. With narrower resolution bandwidth settings, the instantaneous bandwidth is proportionally reduced.

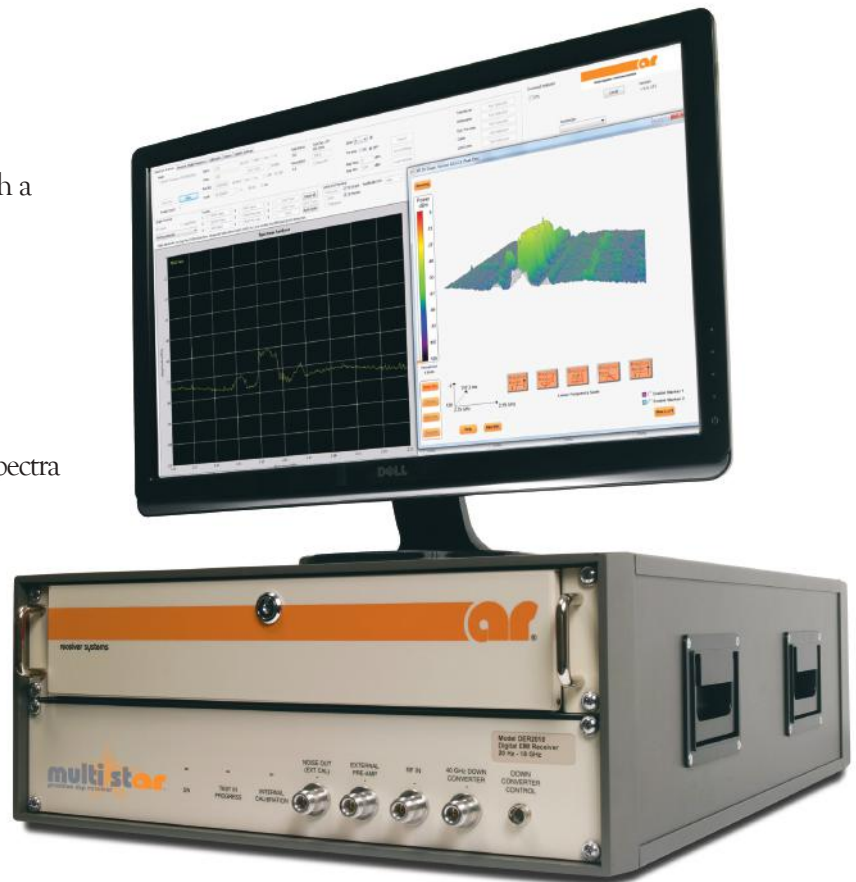

Receiver Accessories

CFE1840 Down Converter 18 – 40 GHz



This low noise, high dynamic range down converter translates signals in the 18–26.5 GHz and 26.5–40 GHz bands (K and Ka bands) to the 4–18 GHz band for further processing by a spectrum analyzer or an EMI test receiver such as the DER2018..

The CFE1840 provides ample gain of RF signals to accommodate long cable runs between the down converter and the EMI test receiver, while maintaining a good noise figure for the system. The CFE1840 has a stable, built-in noise source to facilitate self-test and self-calibration operations. The CFE1840 integrates seamlessly with the DER2018 EMI test receiver, forming a 20 Hz to 40 GHz test system.

LT1000 Transient Limiter 10 Watts, 9 kHz - 100 MHz

The LT1000 Transient Limiter is used to protect and prevent damage to the sensitive RF input of the DER2018 EMI Receiver from power line disturbances when performing EMI measurements. The LT1000 has a constant 10dB loss in the 9kHz to 100 MHz frequency range as well as a high pass filter to attenuate the power line frequency and its respective harmonics.

LN1G18 Low Noise Pre-Amplifier 1 – 18 GHz



The Model LN1G18 is a broadband, self-contained linear amplifier for laboratory applications requiring instantaneous bandwidth and low noise. It has been designed specifically for use with the DER2018 EMI receiver and the ATH1G18A antenna.

The LN1G18, with its low noise figure, can be used to increase the sensitivity of receivers with relatively high noise figures. It also is useful for amplifying low level signals to more useful levels for driving power amplifiers and other similar applications.

LN1G18

	LN1G18
Power Output	+8 dBm at less than 1 dB gain compression
Frequency Response	1.0-18.0 GHz
Gain	20 dB min
Gain Flatness	±3 dB
Noise Figure	3 dB typical
Input Impedance	50 ohms, VSWR 3.0:1 max (1 - 2 GHz), 2.5:1 max (2 - 18 GHz)
Output Impedance	50 ohms, VSWR 2.5:1 max
Mismatch Tolerance	100%, will operate without damage, foldback or oscillation with any magnitude and phase of source and load impedance.
Modulation Capability	Will faithfully reproduce AM, FM, or pulse modulation appearing on the input signal
Harmonic Distortion	-20 dBc max at +0 dBm output
Third Order Intercept Point	+20 dBm typical
Primary Power	7 - 20V, 250mA, fed thru RF cable or DC connector
RF Connectors	Input N (M) Precision Output N (F) Precision
Size (approximate) WxHxD	6.35 x 3.56 x 17.4 cm (2.5 x 1.4 x 6.85 in.)

Receiver Test Set-Ups

Radiated Emissions Test Set-Up

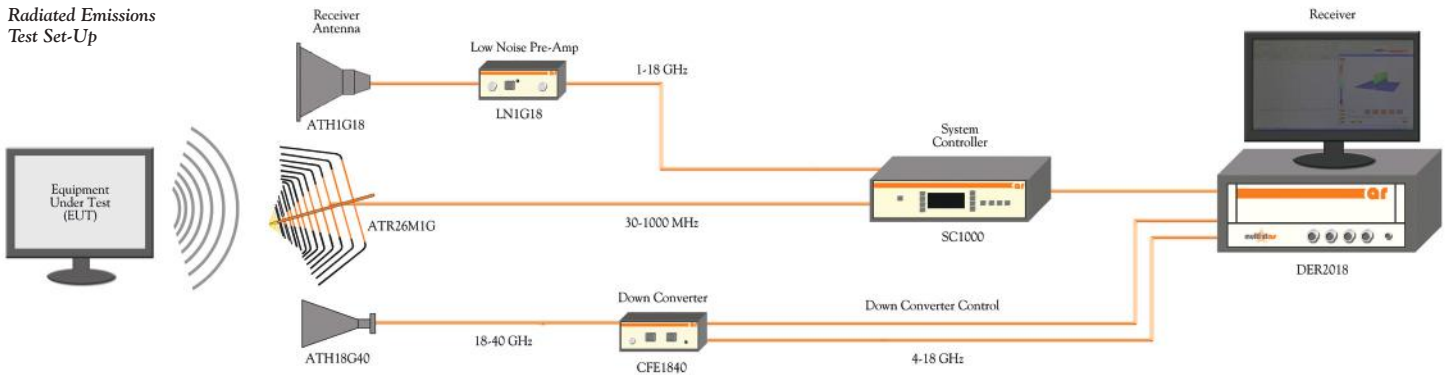

Conducted Emission Test Set-Up

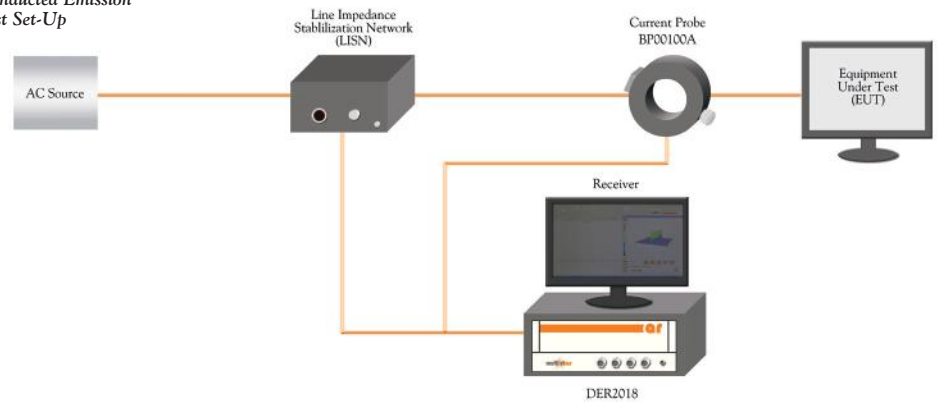

With the addition of the MultiStar Precision DSP Receiver, AR offers a faster, more precise turn-key solution for your emission testing requirements. This state-of-the-art receiver compliments AR's robust lines of antennas, amplifiers, converters, systems, LISNs, and system controllers. Sample system designs with the corresponding AR model numbers are provided for your convenience here. These designs address general Radiated Emissions and Conducted Emissions Testing systems. As always, AR Application Engineers are available to assist you with your customized design requirements. We will work with you to select the appropriate system components, including cabling and racks to match your current and future needs to maximize performance and output integrity. AR is also available to assist with installation and training to insure a successful implementation of your solution.

AR continues to strive to be your one-stop solution provider.

MultiStar Field Analyzers

FA7000 Series Makes Electric Field Measurements Faster, Easier, More Accurate Than Ever

The FA7000 series of Field Analyzers represents a new patent-pending approach to more accurately measure modulated electric fields as well as CW electric fields. This innovative approach uses an isotropic field sensor to sample the composite field and transmit its amplitude digitally over optical fiber to a processor unit. The sample rate of the FA7000 Field Analyzer is 1.5 million samples per second – significantly faster than conventional RF field probes – enabling them to accurately measure pulsed electric fields in the microsecond range.

Each of the FA7000 series analyzer kits provides a web-based, oscilloscope-type display of the instantaneous electric field strength or power density over time and calculates the minimum, maximum, and average field strength of the waveform as displayed. Each kit consists of an isotropic field sensor, glass fiber-optic cabling, and a processor unit. The processor unit stores all of the necessary amplitude corrections for its associated field sensor.

Correction factors for many frequencies are provided with each kit. These factors can be loaded into the processor unit to automatically correct the field readings at user-specified frequencies. When correction factors are applied, the true accuracy of this device is realized.

*Embedded webpage
for viewing the
modulation envelope
of the measured
electric field*



FA7006, FA7218, FA7040, &
FA7060 Processor Unit

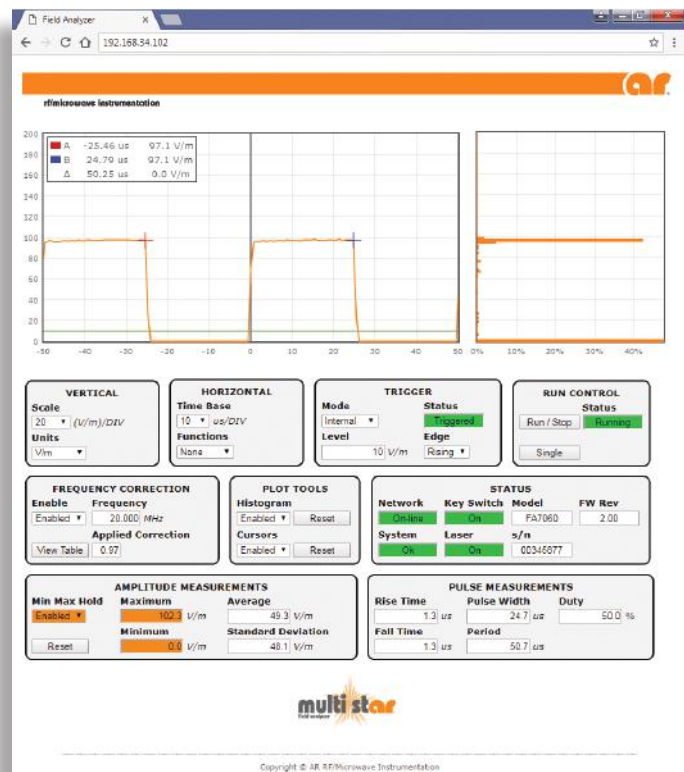

FA7000 Series Processor Unit

Dimensions (W x H x D)	21.91 x 4.45 x 27.69 cm
Weight	1.36 kg
Operating Temperature Range	10°C to 40°C @ 5% to 95% RH non-condensing
Fiber Optic Connector	E2000 compact duplex (Yellow, keying #3)
Fiber Optic Cable length	20m (supplied with kit)
Max Fiber Optic length	100m (sold separately)
Remote Interfaces	LAN (Ethernet) USB 2.0 (Test and Measurement class) IEEE-488 (GPIB) Fiber Optic Serial (FSMA connectors; Reserved for use with FM7004A Field Monitor)
Max Remote Transfer Rate	20 queries per second
External Trigger Port	
Impedance	>10MO
Threshold Voltage	3V
Maximum Input Voltage	5V
Minimum Pulse Width	40ns
Readout Display	Embedded Web Application through PC (PC not included)
Remote Interface	LAN (Ethernet)
Compatible Web Browsers	Chrome, Internet Explorer, Safari, Firefox, Opera
Timebase Range	1 μ s/Div to 400 μ s/Div
Scale Range	0.1 (V/m)/Div to 5000 (V/m)/Div
Trigger Modes	Free Run, Internal (conventional threshold), External
Edges (Threshold trigger)	Rising and Falling
Vertical Divisions	10
Horizontal Divisions	10
Laser	
Wavelength	830nm
Output Power	\leq 500mW
Shutdown Time	<1 ms after fiber disconnect
Power Requirements	
Input Voltage	90-260 VAC, 50-60Hz
Input Current	0.2-0.6A
Input type	IEC inlet with filter
Sample Rate	1.5MS/s
Max Record Length	6kPoints
Modulation Frequency Range	250 Hz to 750 kHz
Measurement Format	Composite only
Calibration Data	Accredited Calibration Report supplied with kit



FA7006 Field Sensor



FA7218,
FA7040, &
FA7060
Field Sensor

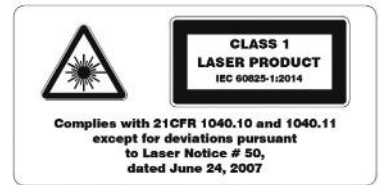

FA7000 Series Field Sensors

	FA7006	FA7218	FA7040	FA7060
Amplitude Accuracy ¹	\pm 1.0dB @ 10 MHz ² 0.8dB, 100 kHz-1 GHz ^{3,4} 1.4dB, 1 GHz-6 GHz ^{3,4}	\pm 1.0dB @ 10 MHz ² 0.8dB, 2 MHz-1 GHz ^{3,4} 1.4dB, 1 GHz-18 GHz ^{3,4}	\pm 1.0dB @ 10 MHz ² 0.8dB, 2 MHz-1 GHz ^{3,4} 1.4dB, 1 GHz-40 GHz ^{3,4}	\pm 1.0 dB @ 10 MHz ² 0.95dB, 2 MHz-1 GHz ^{3,4} 1.5dB, 1 GHz-60 GHz ^{3,4}
Isotropic Deviation ^{4,5}	\pm 1.2dB @ 10 MHz \leq 200V/m \pm 2.0dB @ 10 MHz > 200V/m	\pm 1.0dB @ 10 MHz \leq 200V/m \pm 2.0dB @ 10 MHz > 200V/m	\pm 1.0dB @ 10 MHz \leq 200V/m \pm 2.0dB @ 10 MHz > 200V/m	\pm 1.0dB @ 10 MHz \leq 200V/m \pm 2.0dB @ 10 MHz > 200V/m
Operating Range ⁹	9-900V/m	14-1400V/m	14-1400V/m	14-1400V/m
Linearity	\pm 0.5dB	\pm 0.5dB	\pm 0.5dB	\pm 0.5dB
Typical Analog Rise Time ^{6,7}	300nS	300nS	300nS	300nS
Minimum Pulse Width	1 μ s	1 μ s	1 μ s	1 μ s
Damage Level (CW)	1000V/m	1200V/m	1200V/m	1200V/m
Temperature Stability	\pm 1.0dB, 10°C-40°C ⁸	\pm 1.0dB, 10°C-40°C ⁸	\pm 1.0dB, 10°C-40°C ⁸	\pm 1.0dB, 10°C-40°C ⁸
Approximate Dimensions (w x h x d)	5.7 x 5.7 x 5.7 cm	27.8 x 6.5 x 6.5 cm	27.8 x 6.5 x 6.5 cm	27.8 x 6.5 x 6.5 cm
Weight	62.5g	150g	150g	150g

¹ Single axis aligned with field

² Without correction factors applied

³ With correction factors applied

⁴ Typical expanded measurement uncertainty (95% confidence interval)

⁵ Measured at the ortho angle

⁶ 10% - 90%

⁷ Pre-digitization

⁸ 5% - 95% Relative humidity, non-condensing

⁹ Less than 50% duty